

# 72 Bed Trailer Mobile Hospital

3D design booklet

**SAMHOON**

January 2021

First edition

## Hospital outline plan:

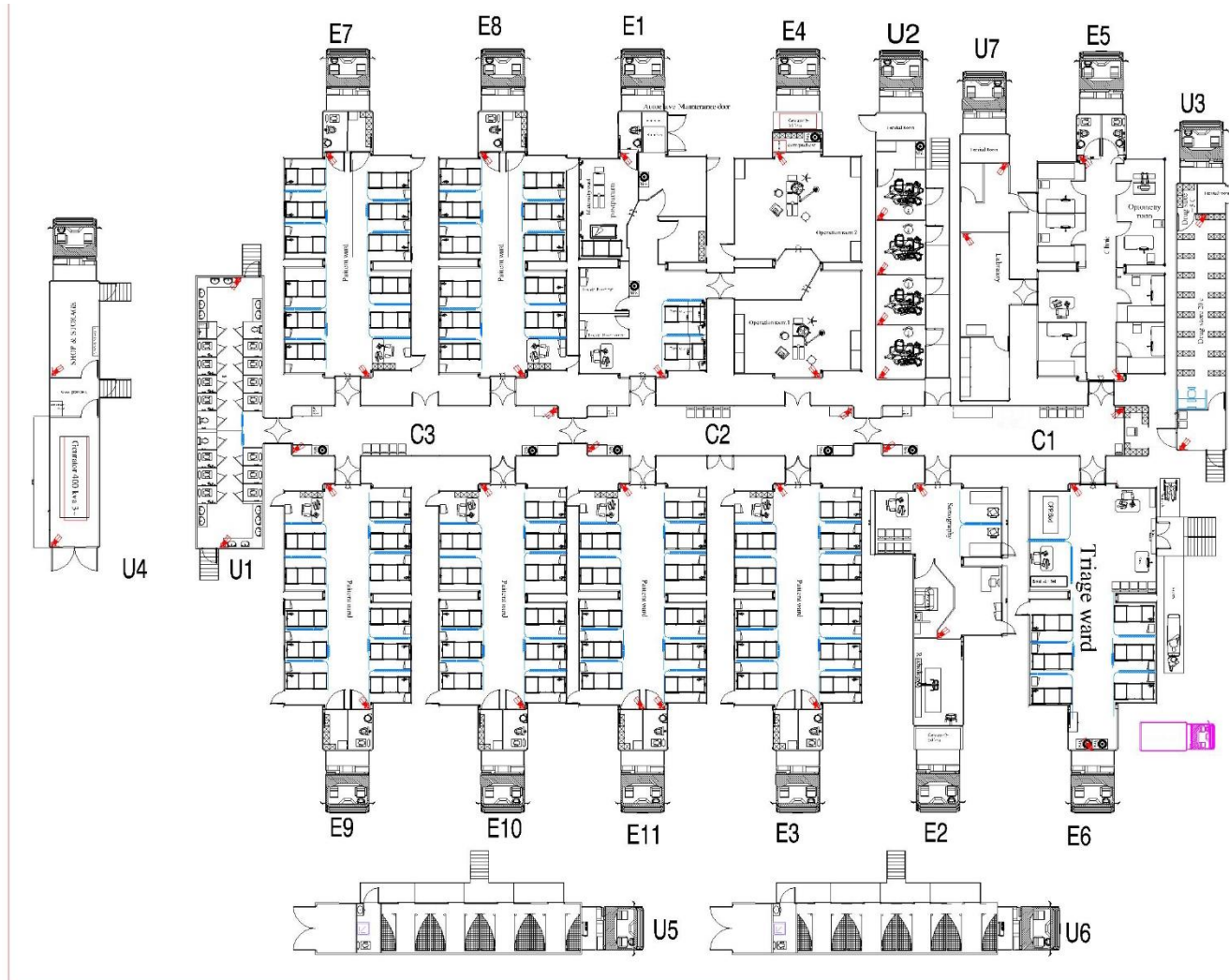

3D images of the project:

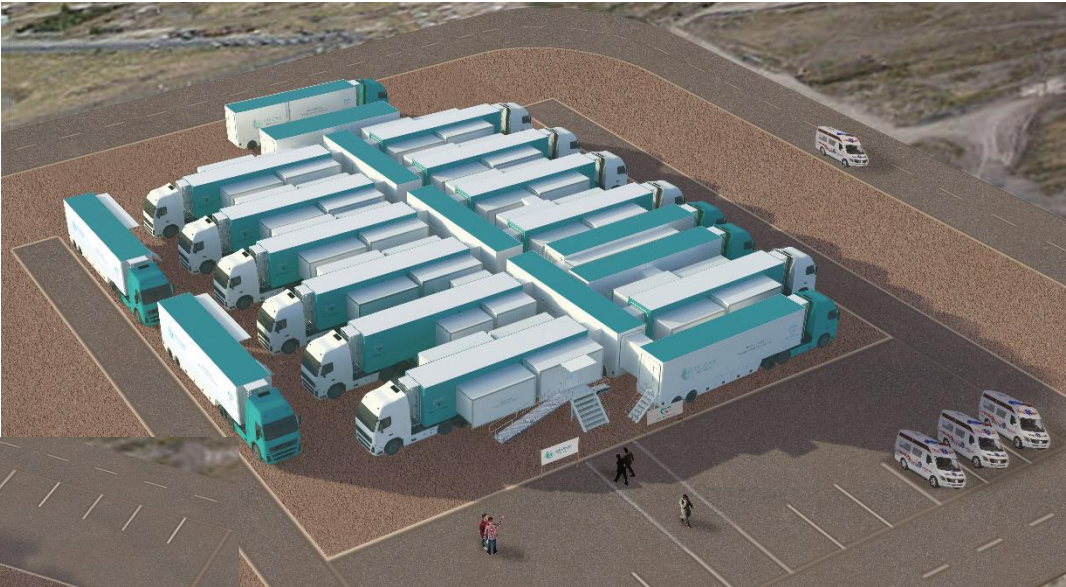

## **Table of Contents**

**1- General unit without internal equipment**

**2-E1: Support for surgery unit**

**3- E2: Radiology**

**4- E3, E7, E8, E9, E10, E11: Patient ward**

**5- E4: Surgery unit**

**6- E5: Clinic**

**7- E6: Triage**

**8- U1: Restrooms**

**9- U2: Dentistry**

**10- U3: Pharmacy**

**11-U4: Generator**

**12-U5, U6: Rest unit for employees**

**13-U7: Laboratory**

**14-C1, C2, C3: Corridor**

## 1- General unit without internal equipment

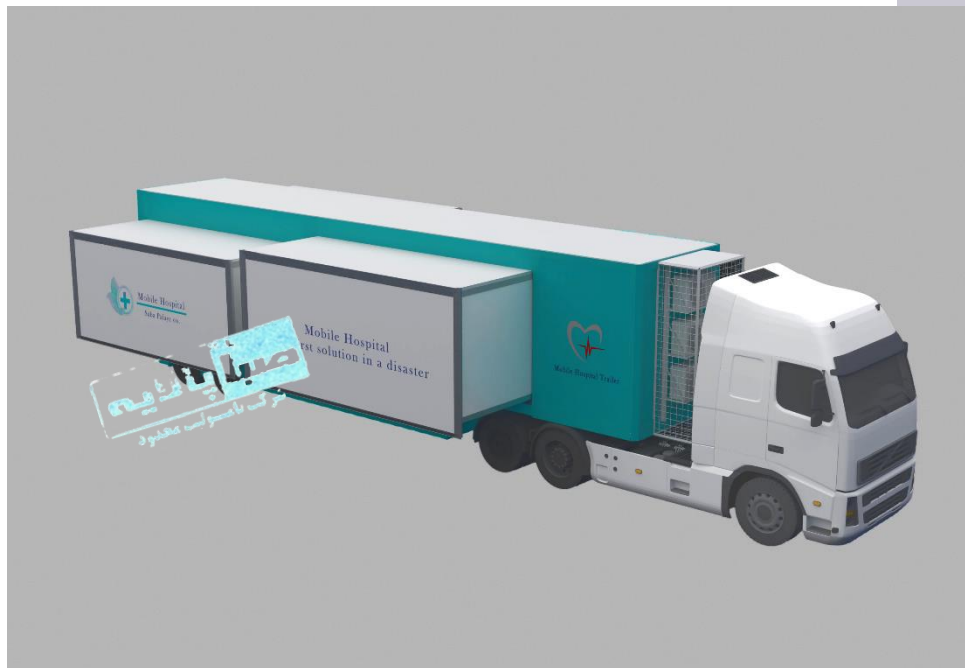

## General unit without internal equipment



# General unit without internal equipment

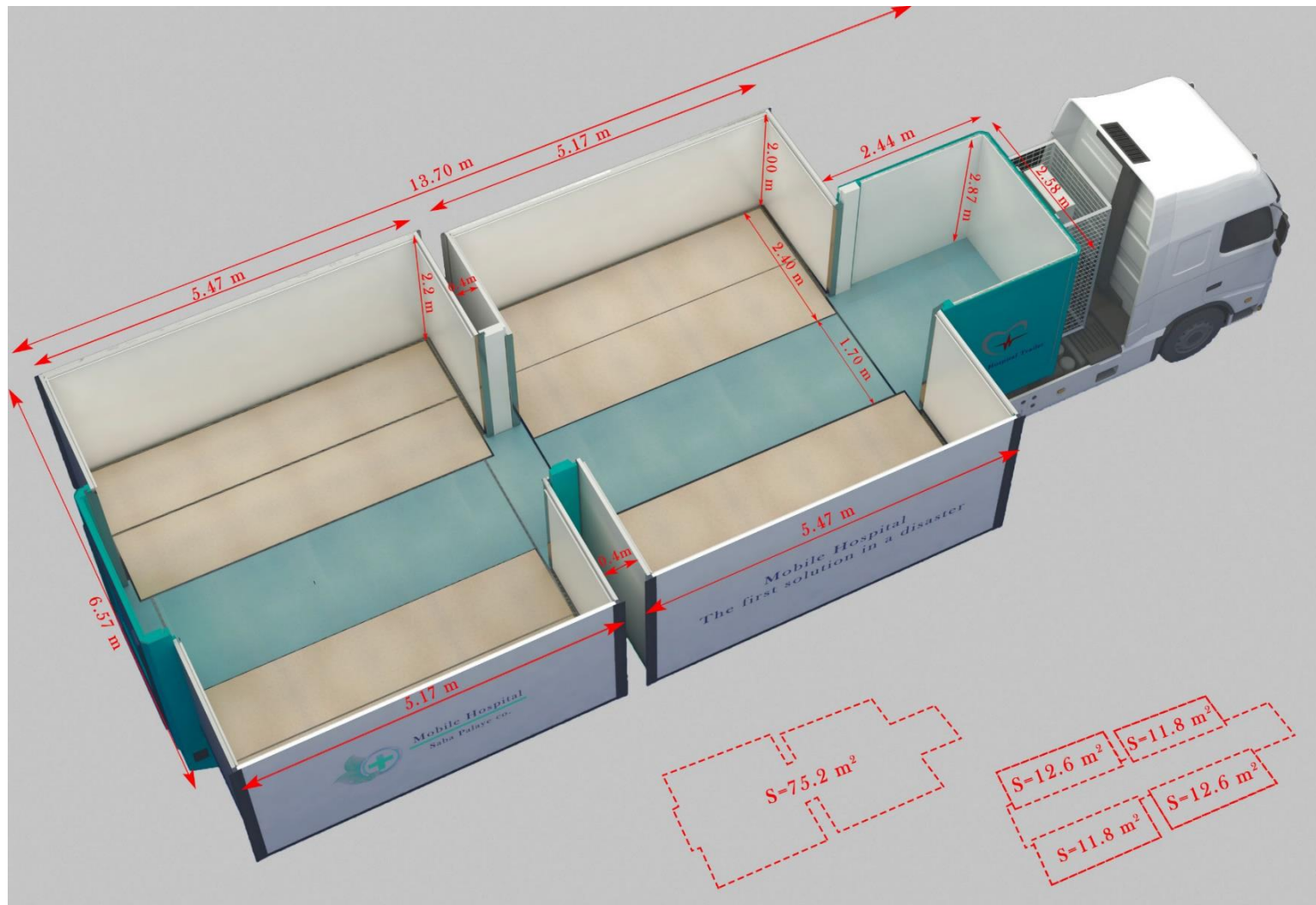

## 2-E1: Support for surgery unit

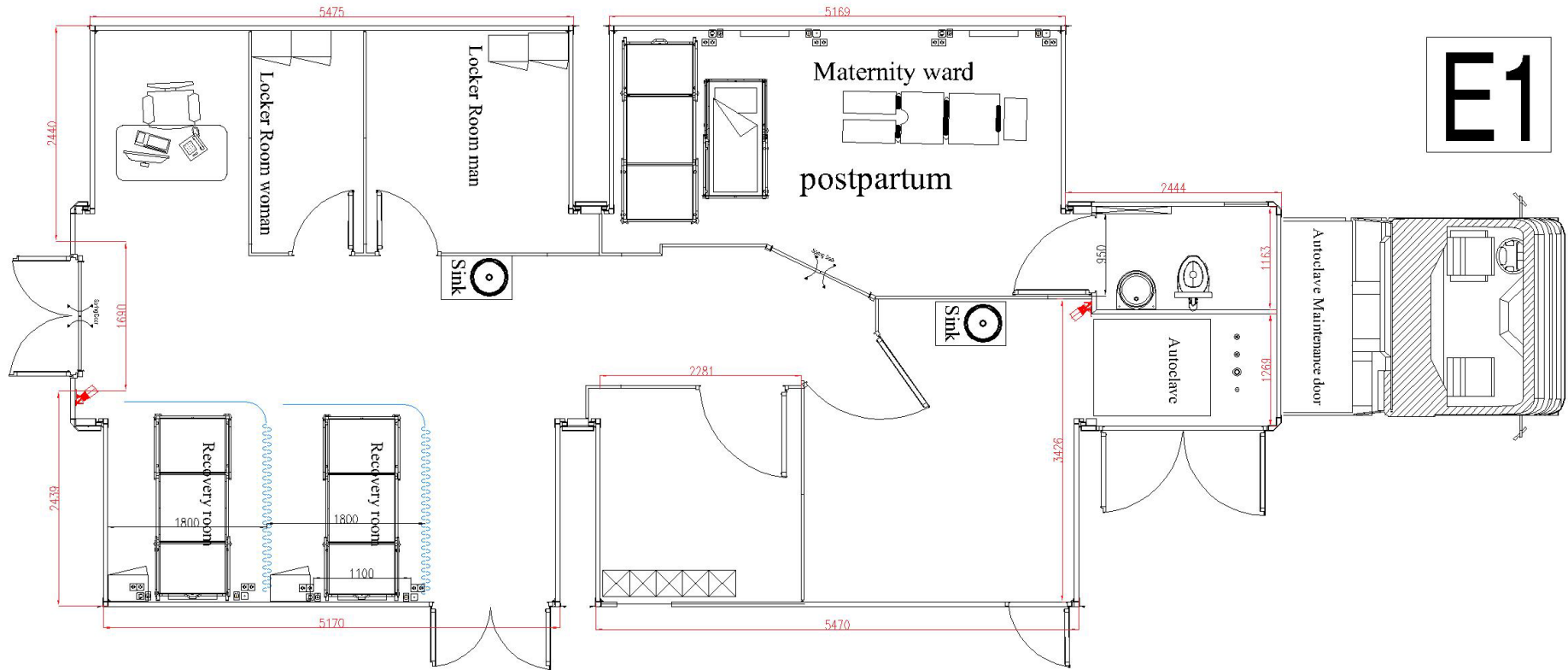

**E1: Support for surgery unit- Main corridor**



**E1: Support for surgery unit- Reception and locker room**



**E1: Support for surgery unit- maternity ward**



**E1: Support for surgery unit- Clean work room**



2-E1: Support for surgery unit- Dirty work room



**E1: Support for surgery unit**



**E1: Support for surgery unit**



### 3- E2: Radiology

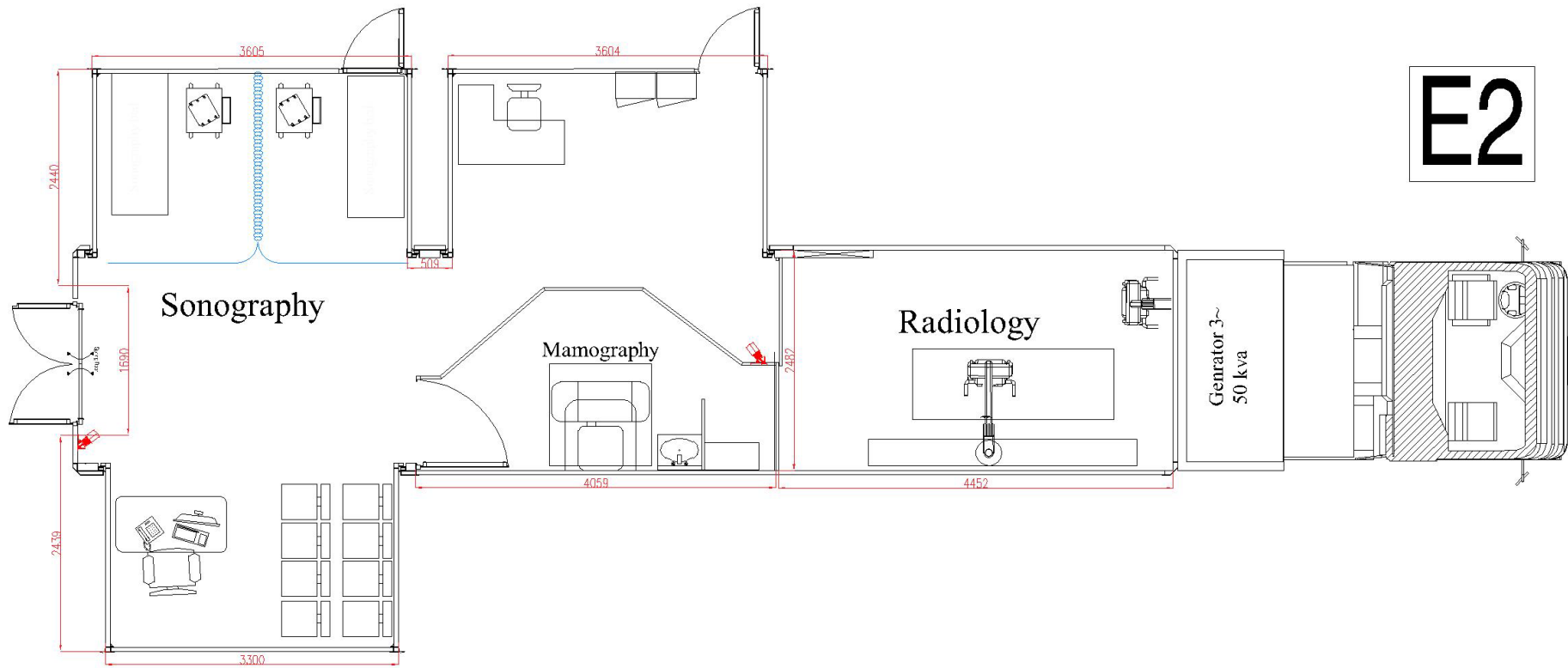

**3- E2: Radiology - Reception and waiting area**



**E2: Radiology- sonography**



**E2: Radiology- Mammography**



**E2: Radiology- Radiology**



**E2: Radiology - Control and review section**



**E2: Radiology**



**E2: Radiology**

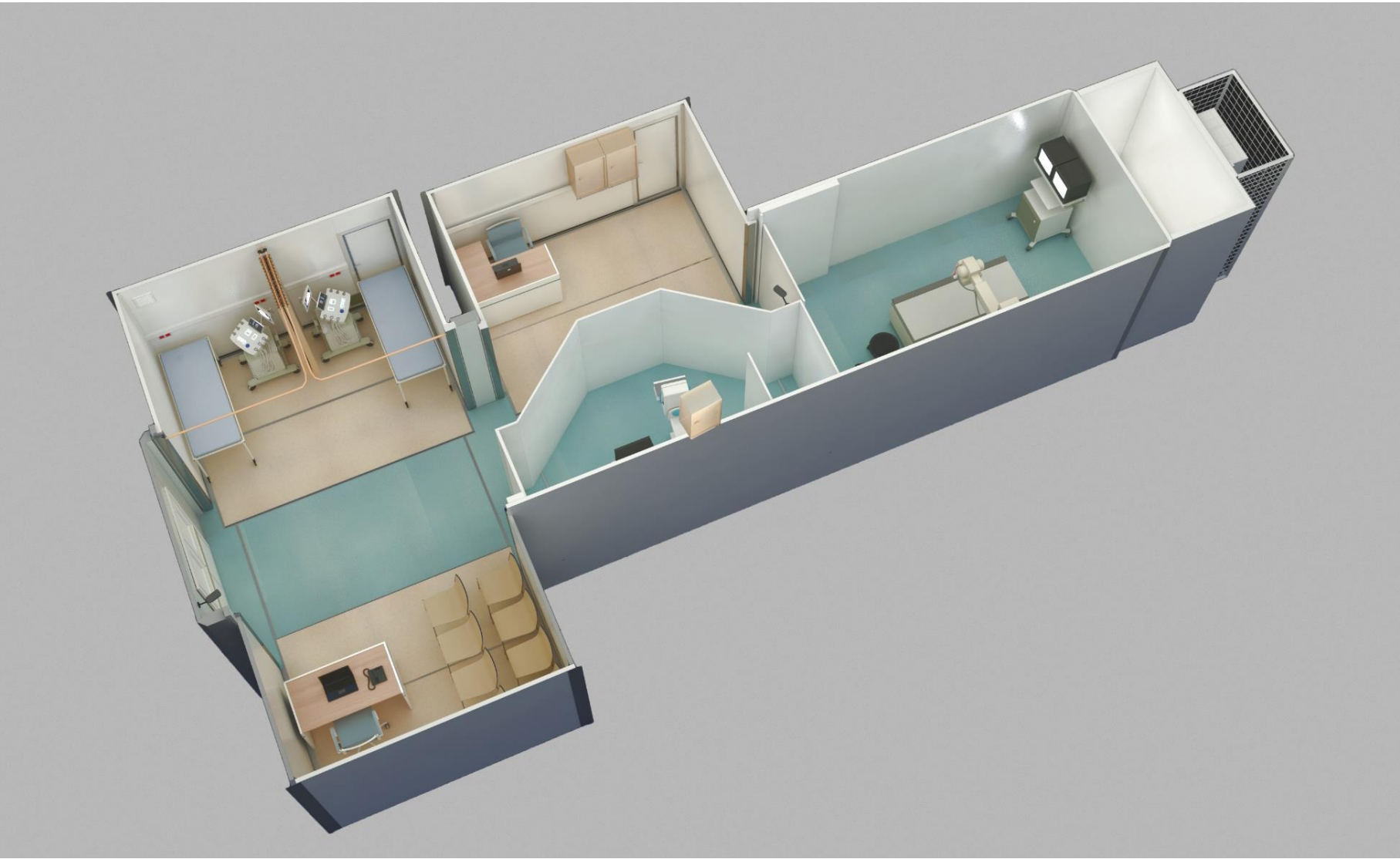

4- E3, E7, E8, E9, E10, E11: Patient ward

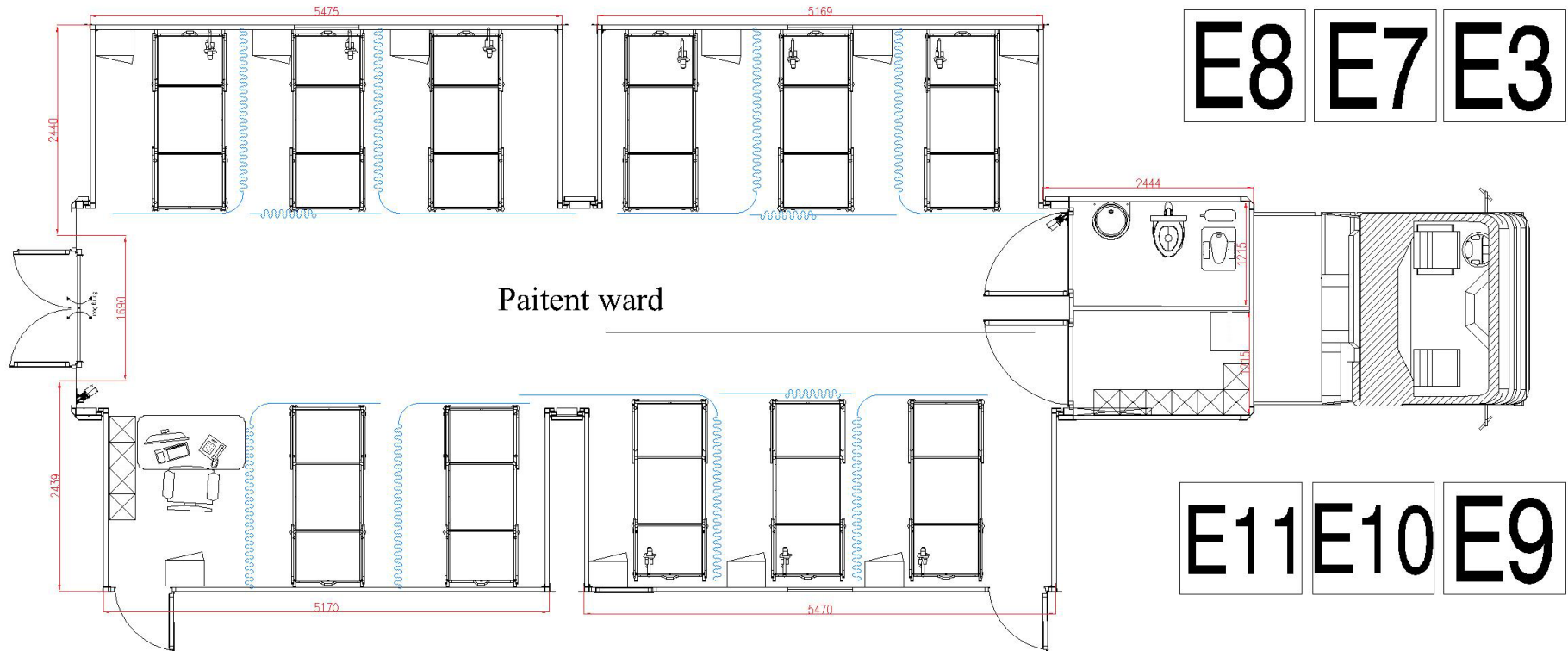

**E3, E7, E8, E9, E10, E11: Patient ward**



E3, E7, E8, E9, E10, E11: Patient ward



E3, E7, E8, E9, E10, E11: Patient ward- Nurse station



**E3, E7, E8, E9, E10, E11: Patient ward**

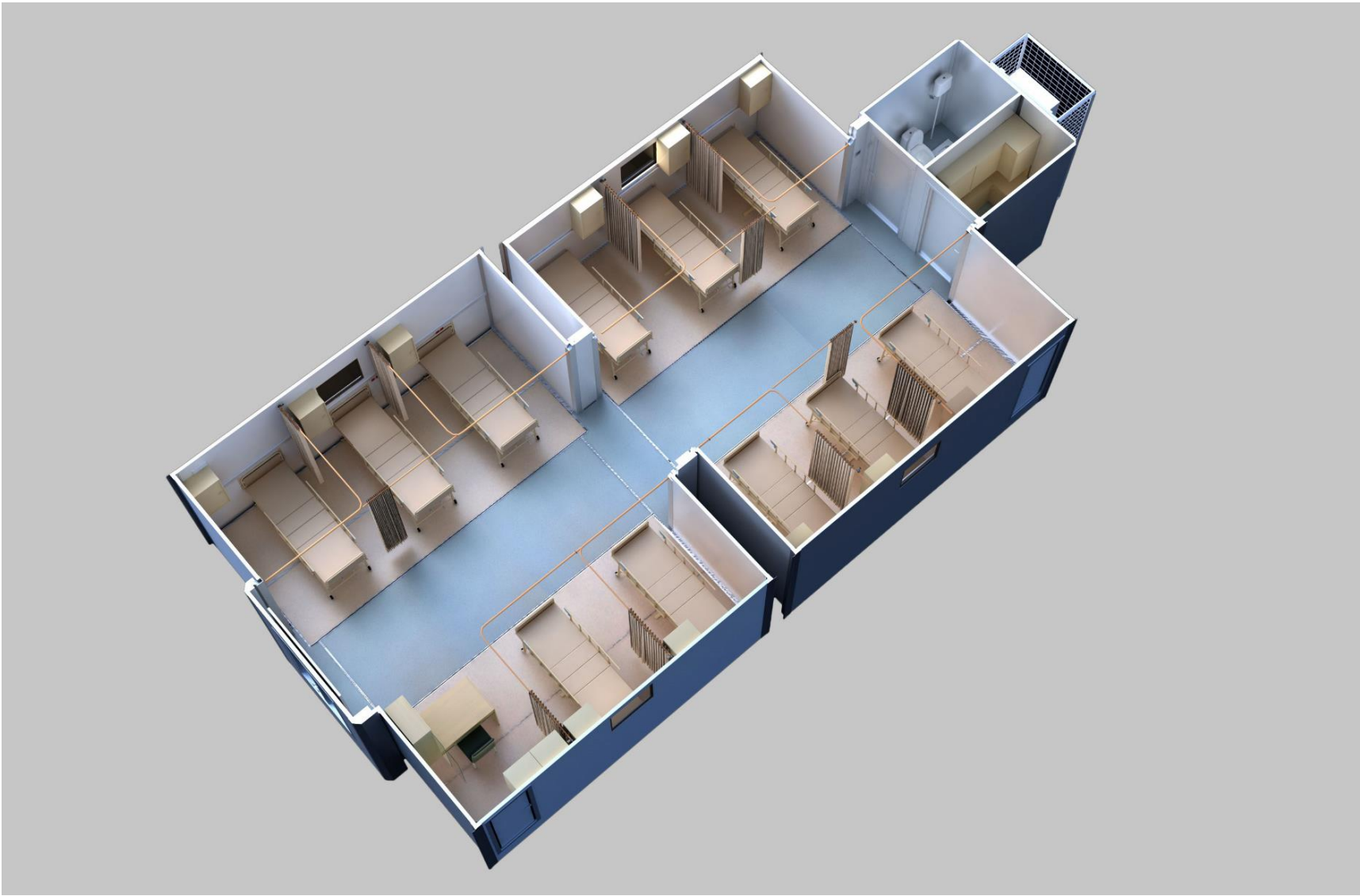

**E3, E7, E8, E9, E10, E11: Patient ward**

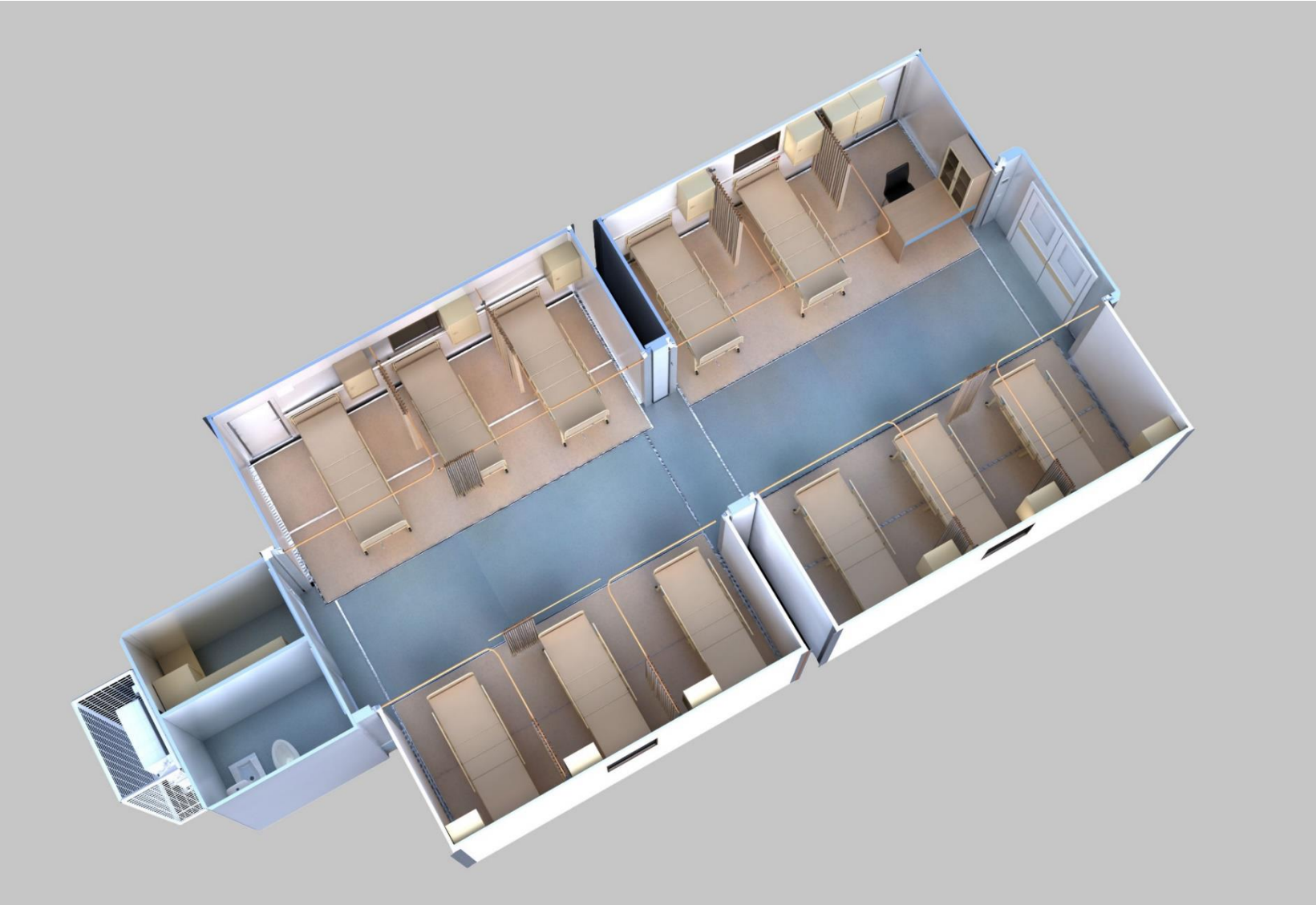

# 5- E4: Surgery unit

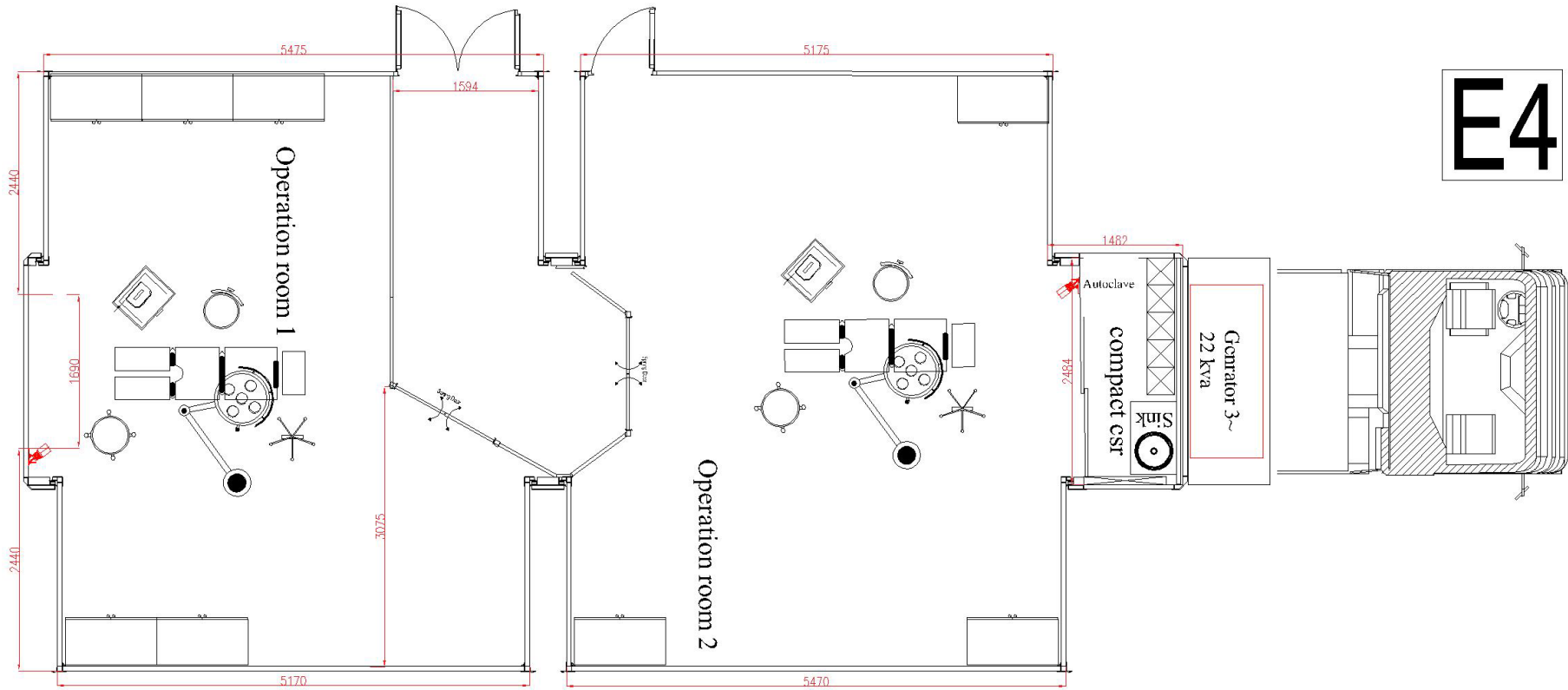

**E4: Surgery unit- surgery room**



**E4: Surgery unit- surgery room**



**E4: Surgery unit- surgery room**



**E4: Surgery unit- Main corridor**



E4: Surgery unit- compact csr



**E4: Surgery unit**

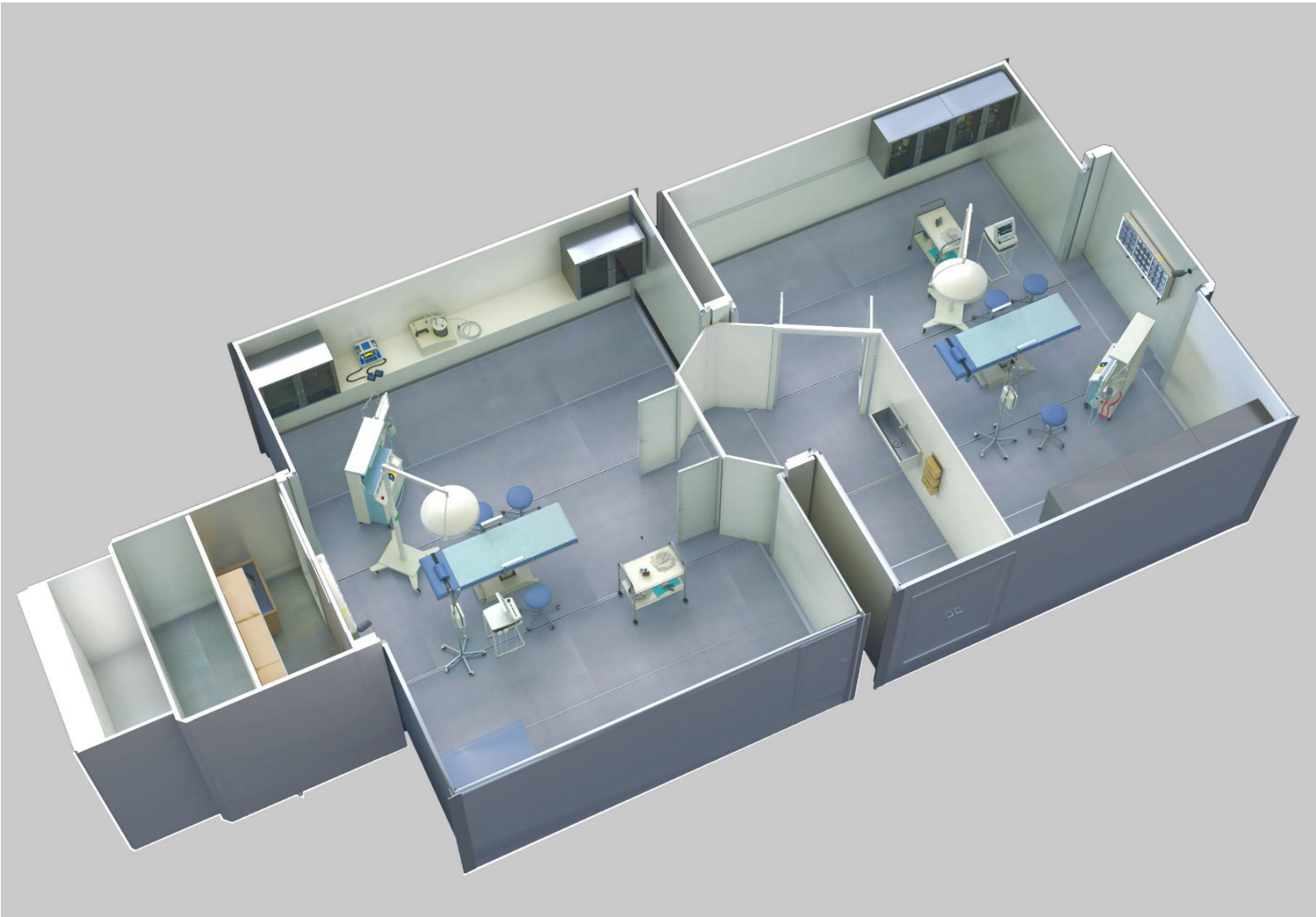

**E4: Surgery unit**

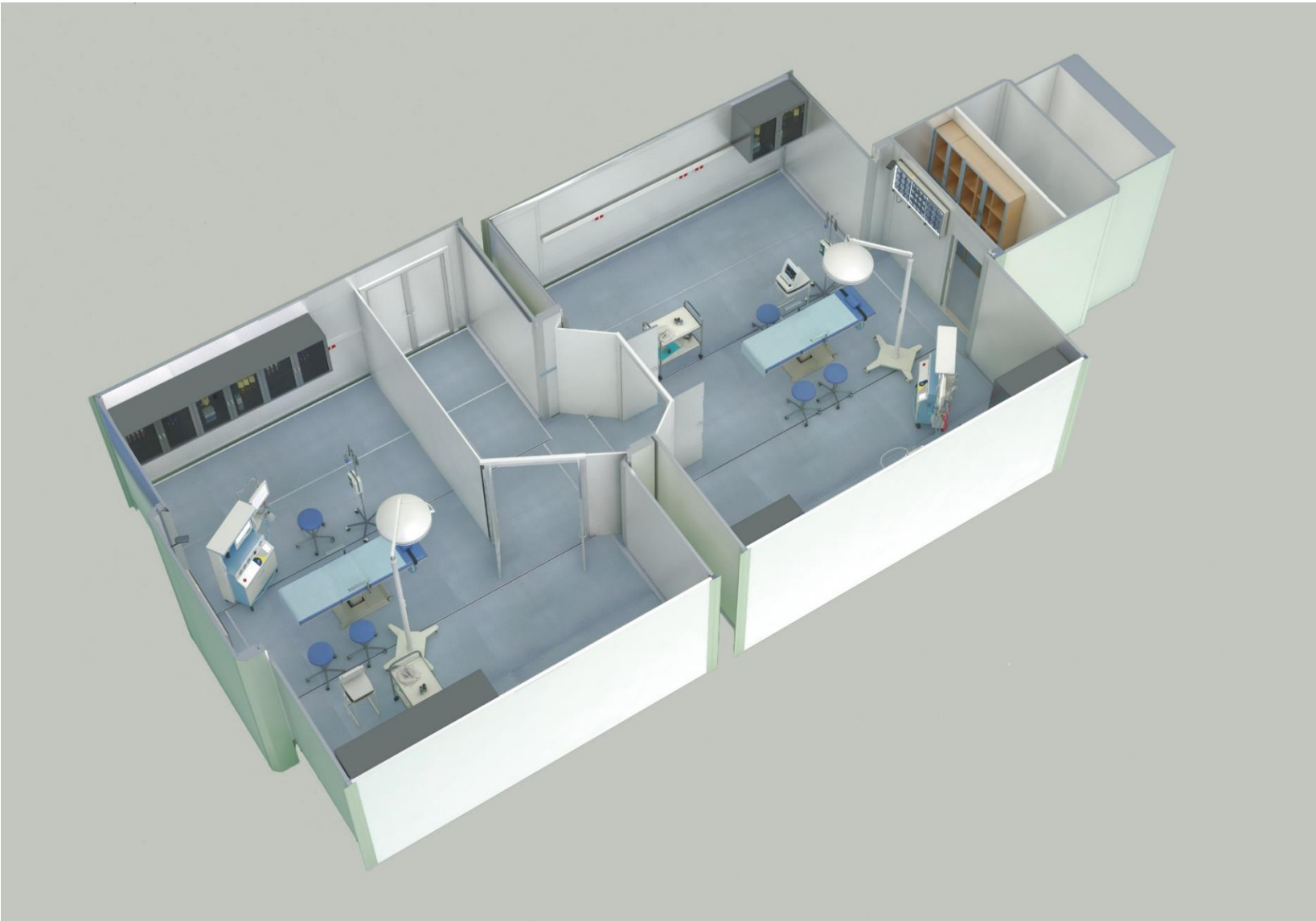

# 6- E5: Clinic

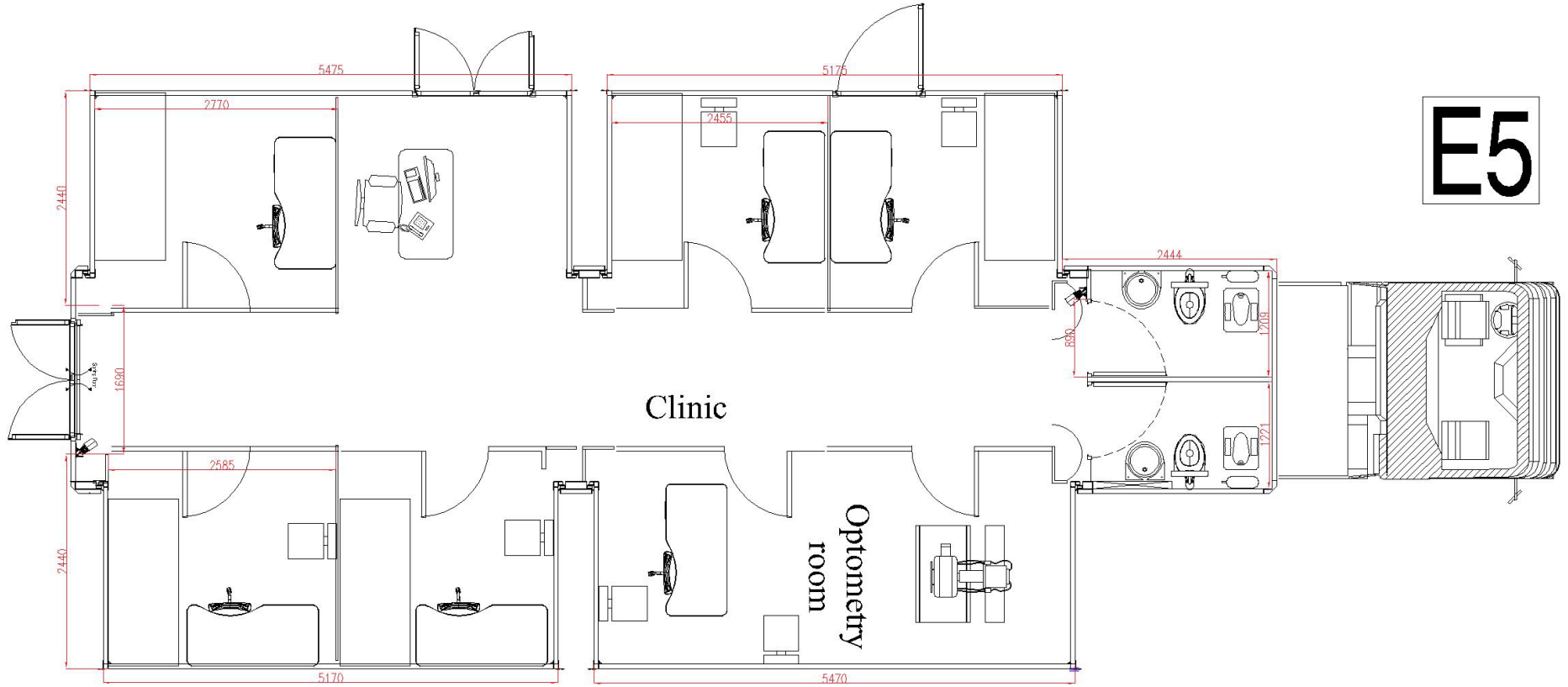

**E5: Clinic- Reception and waiting area**



E5: Clinic- optometry room



E5: Clinic- optometry room



**E5: Clinic- Main corridor**



**E5: Clinic- examination room**



E5: Clinic

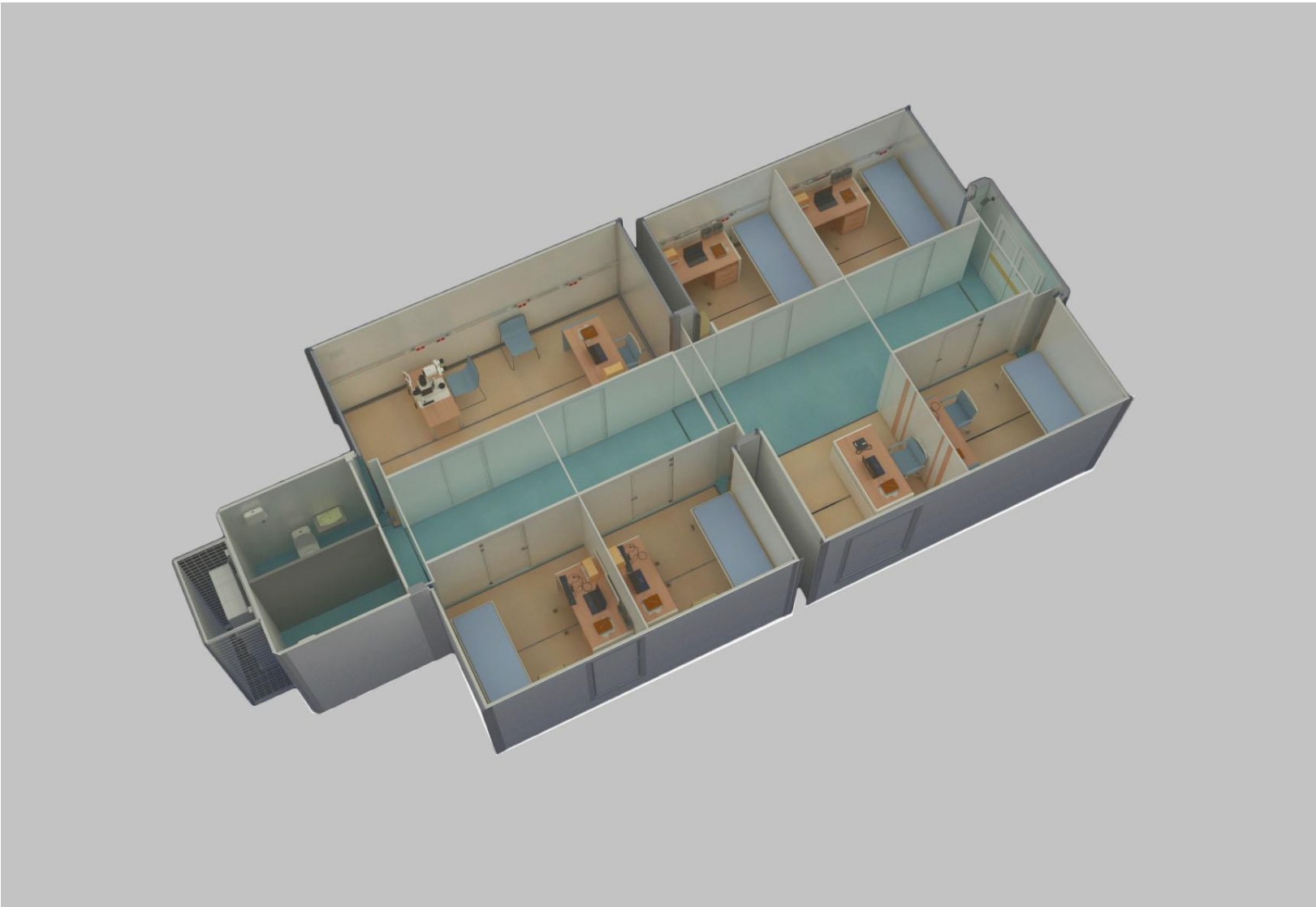

E5: Clinic

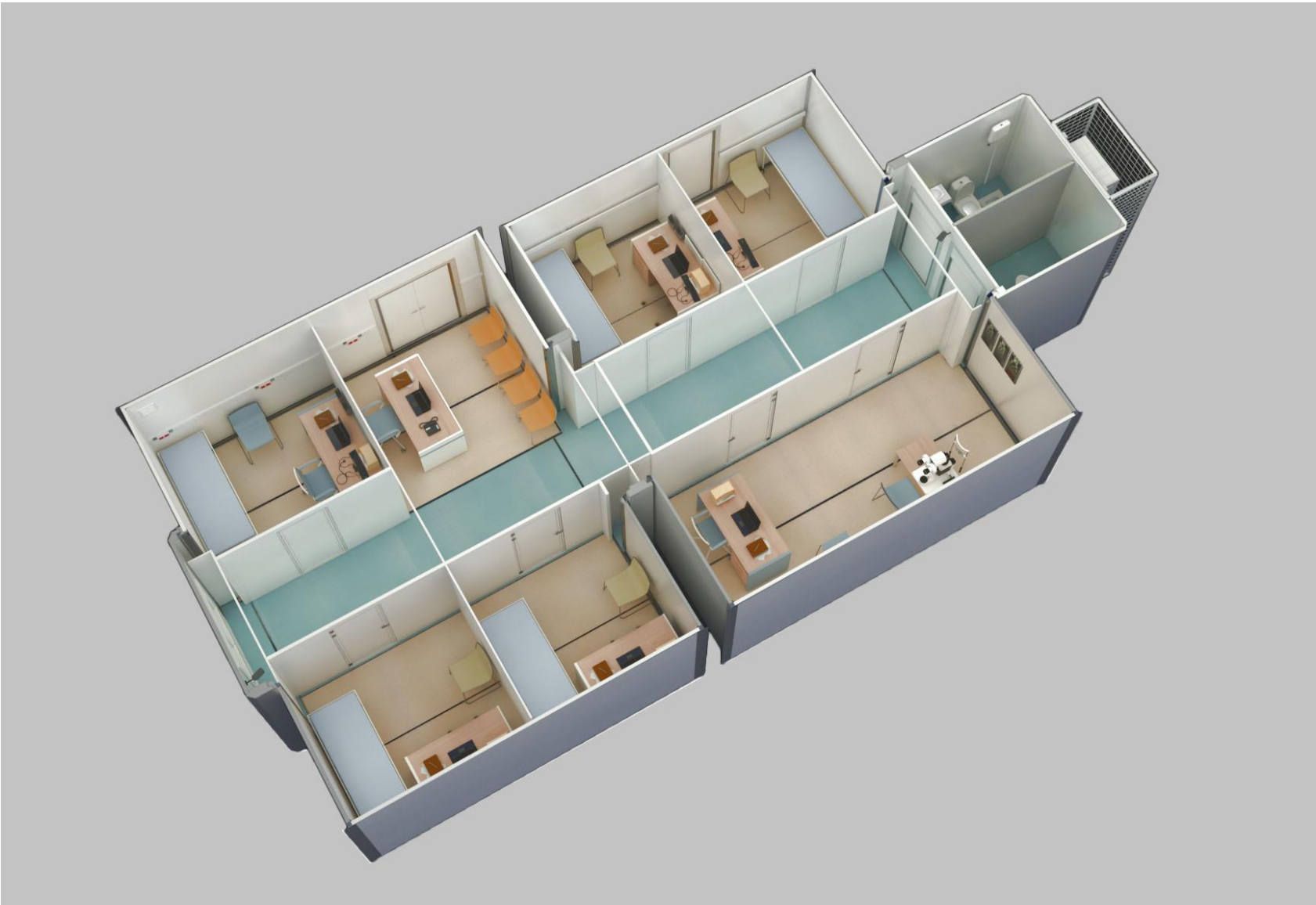

## 7- E6: Triage

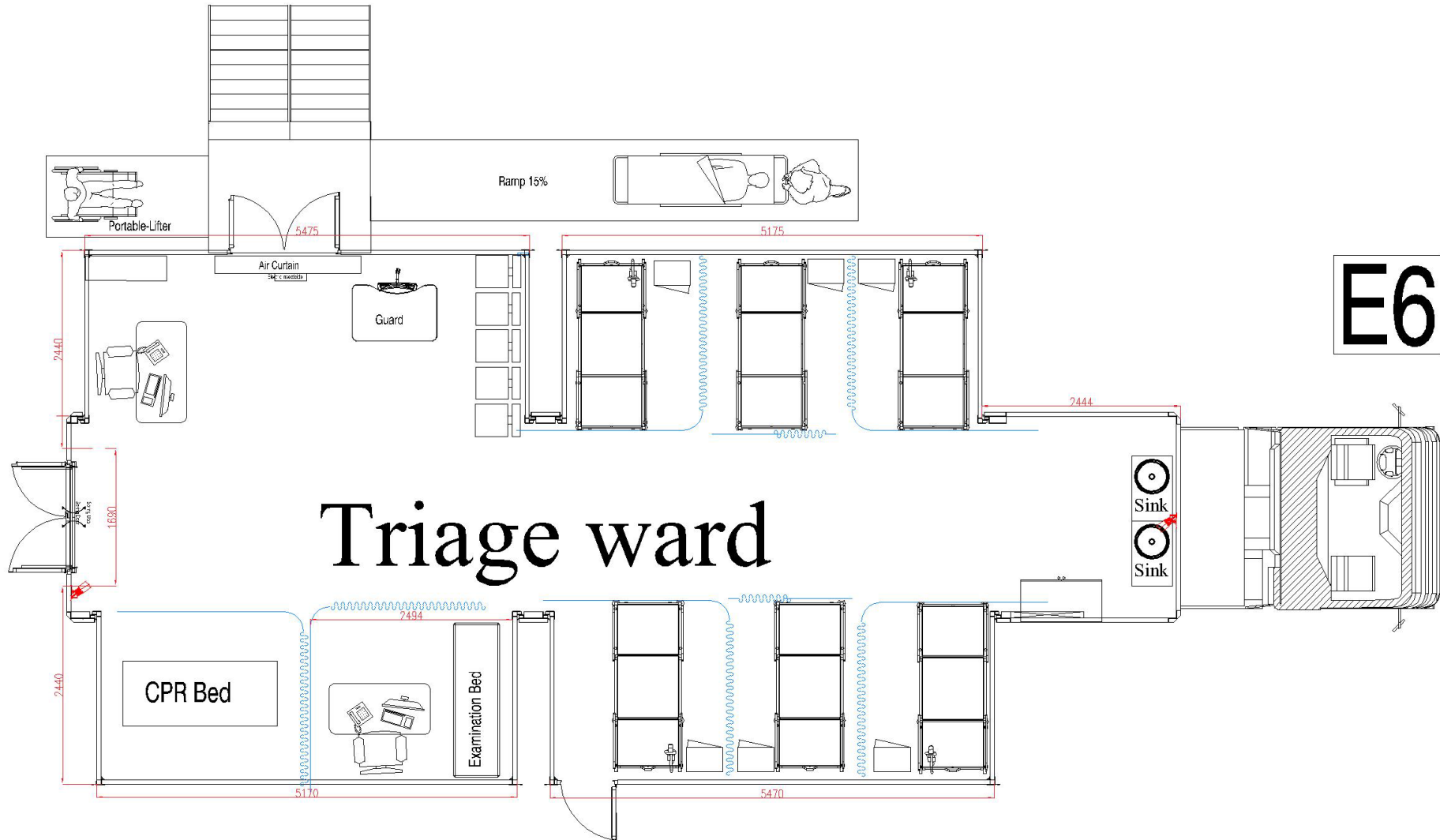

**E6: Triage – Cpr bed and examination**



**E6: Triage - Cpr bed and examination**



E6: Triage



E6: Triage -Entrance



E6: Triage

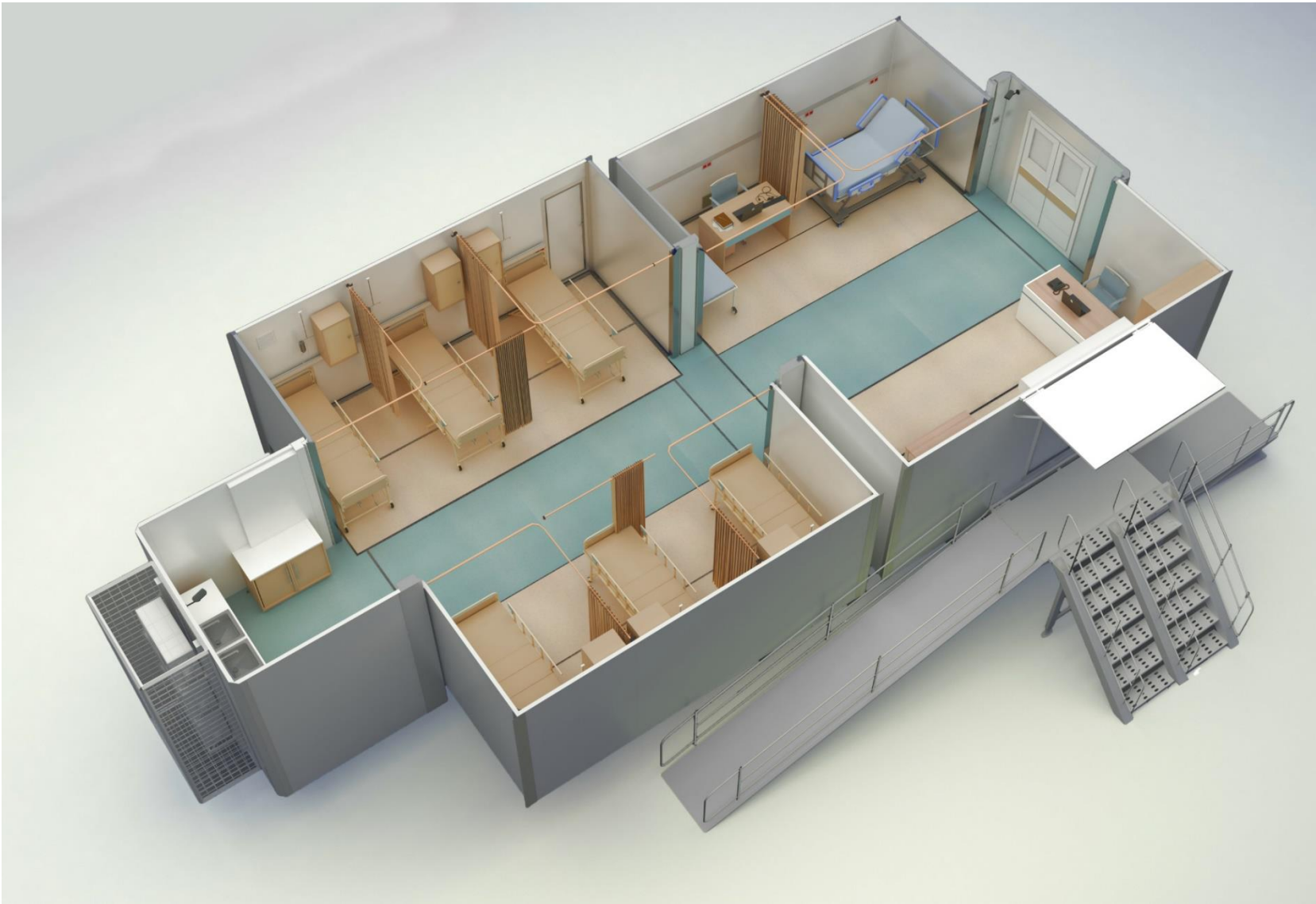

E6: Triage

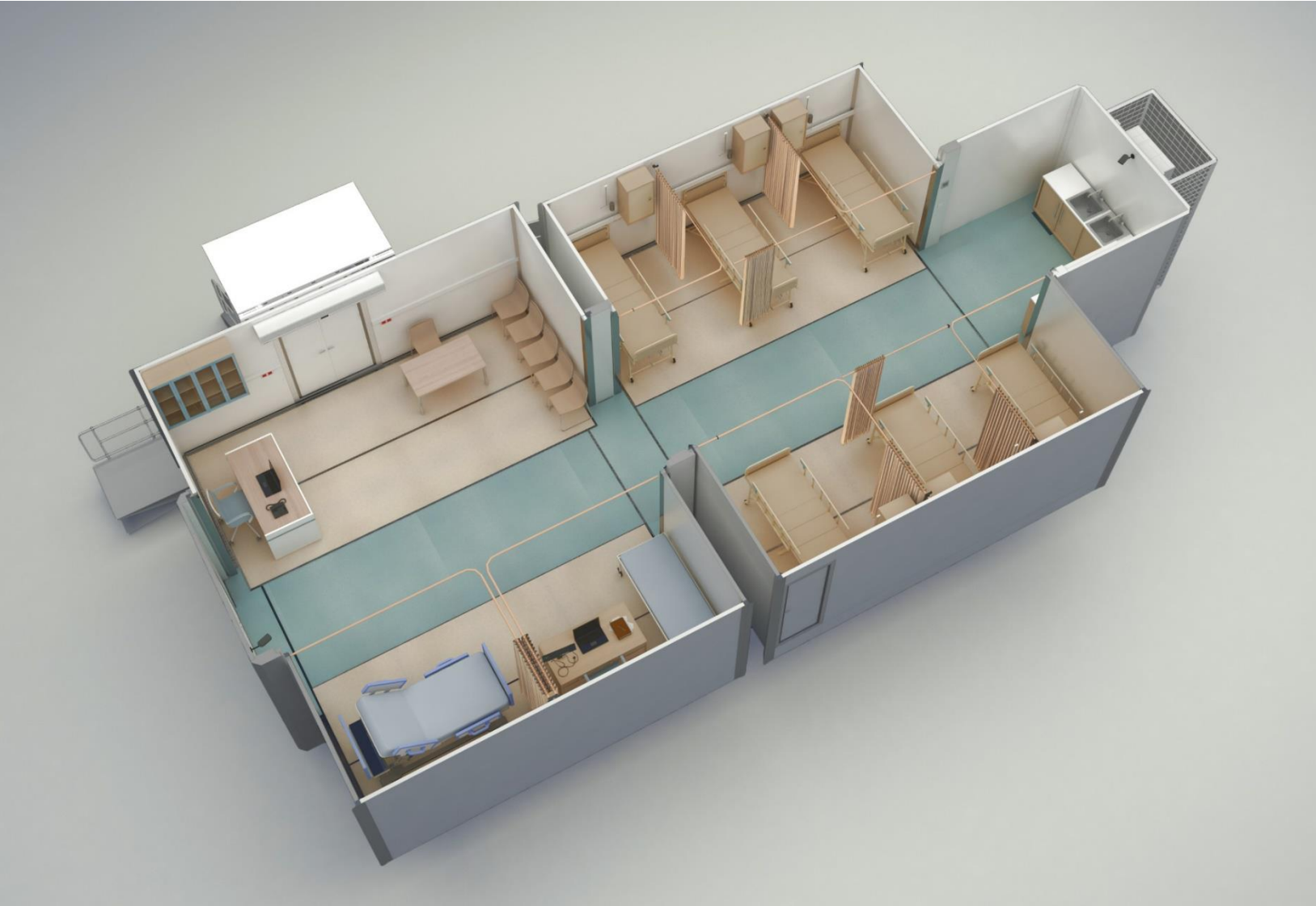

## 8- U1: Restrooms

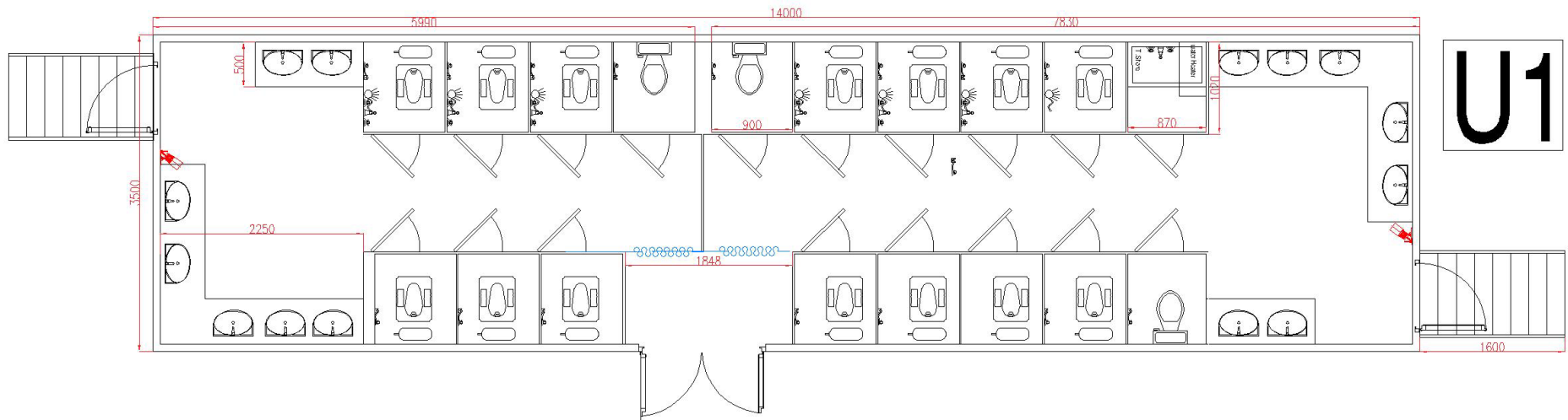

**U1: Restrooms**



**U1: Restrooms**



**U1: Restrooms**

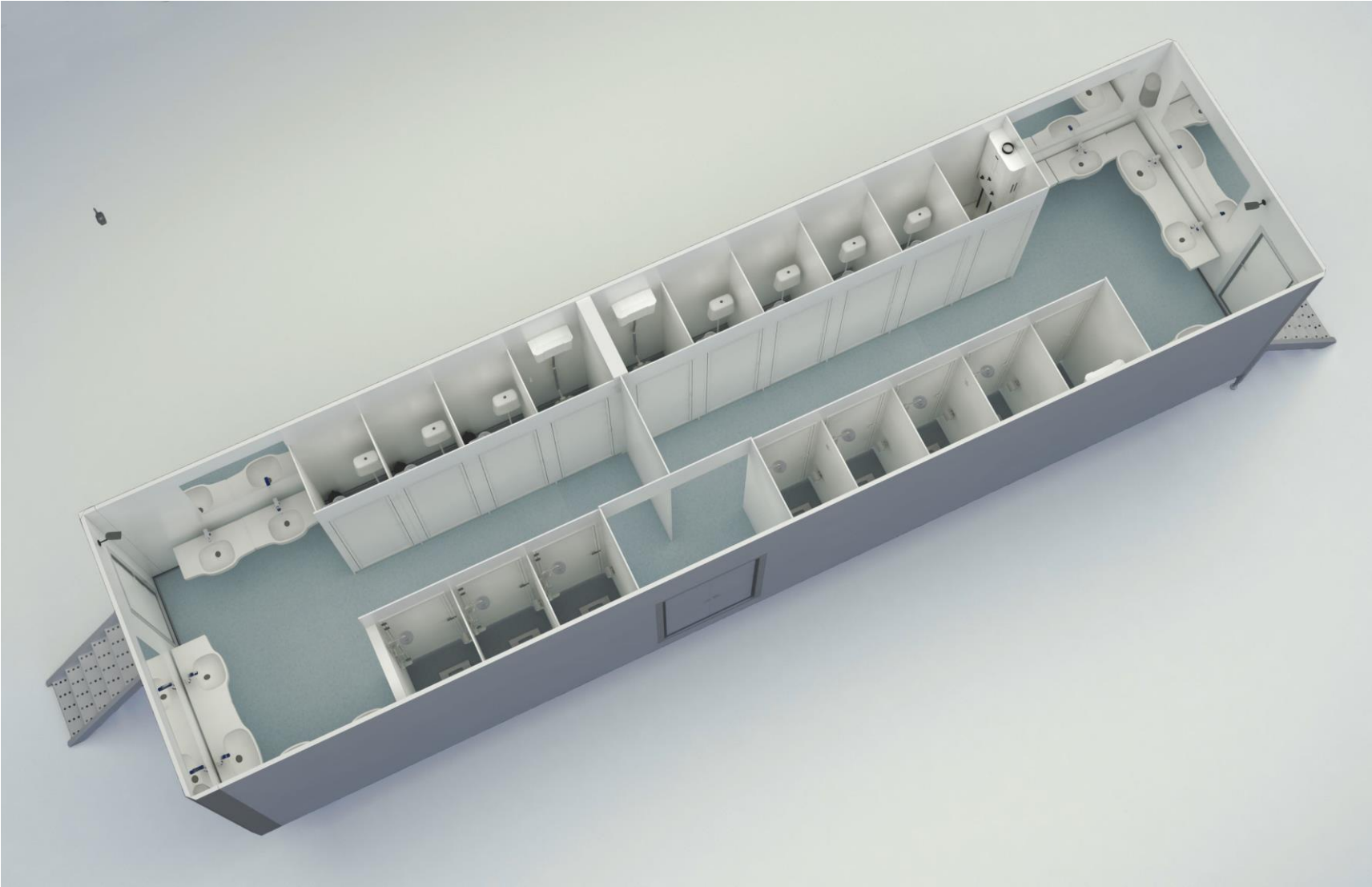

# 9- U2: Dentistry

U2

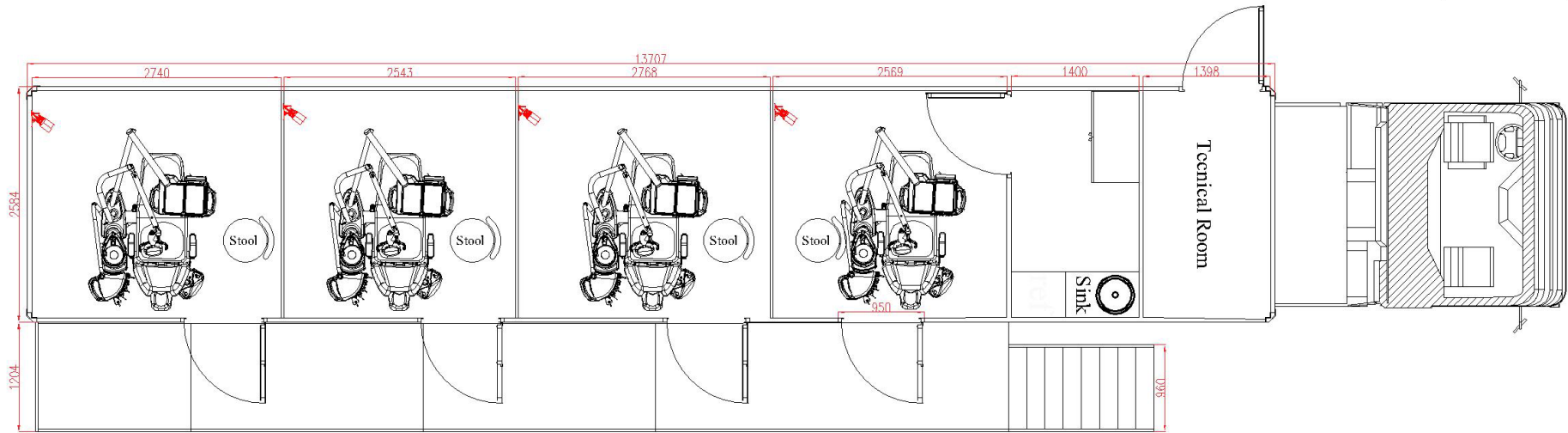

**U2: Dentistry**



**U2: Dentistry**



**U2: Dentistry**

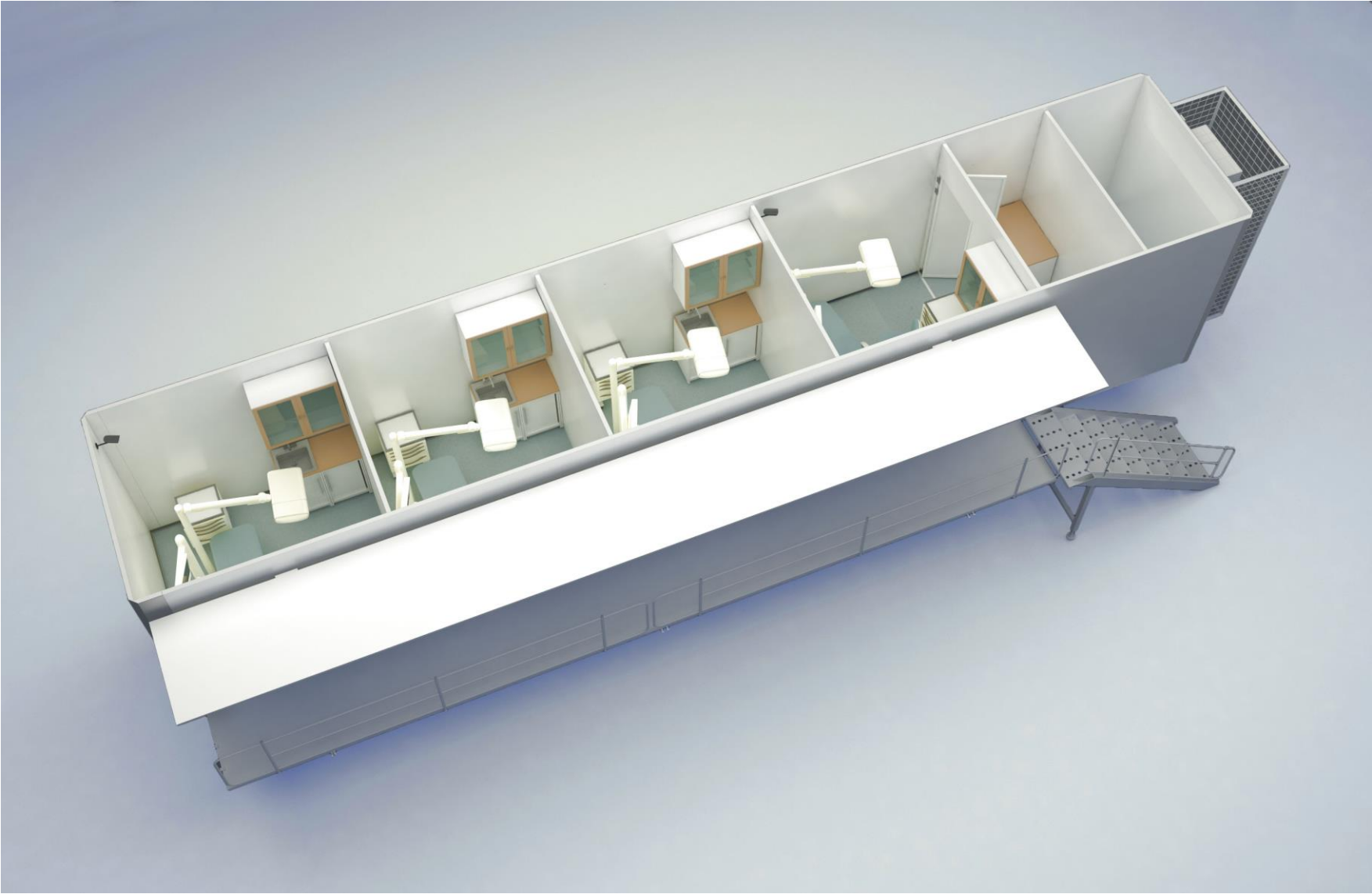

10- U3: Pharmacy

U3

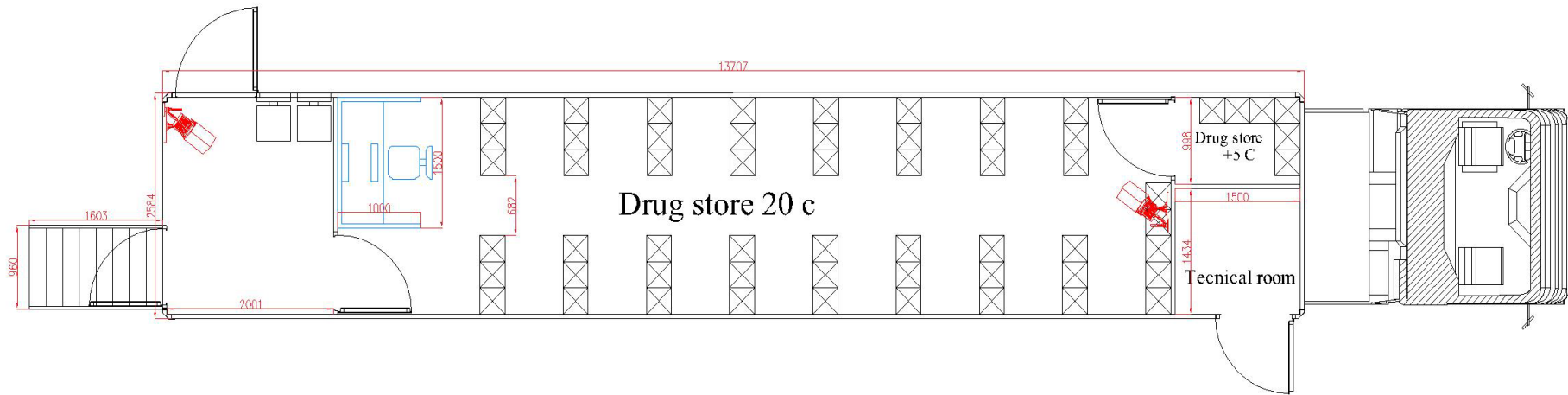

**U3: Pharmacy**



**U3: Pharmacy**



**U3: Pharmacy- Entrance**



**U3: Pharmacy**

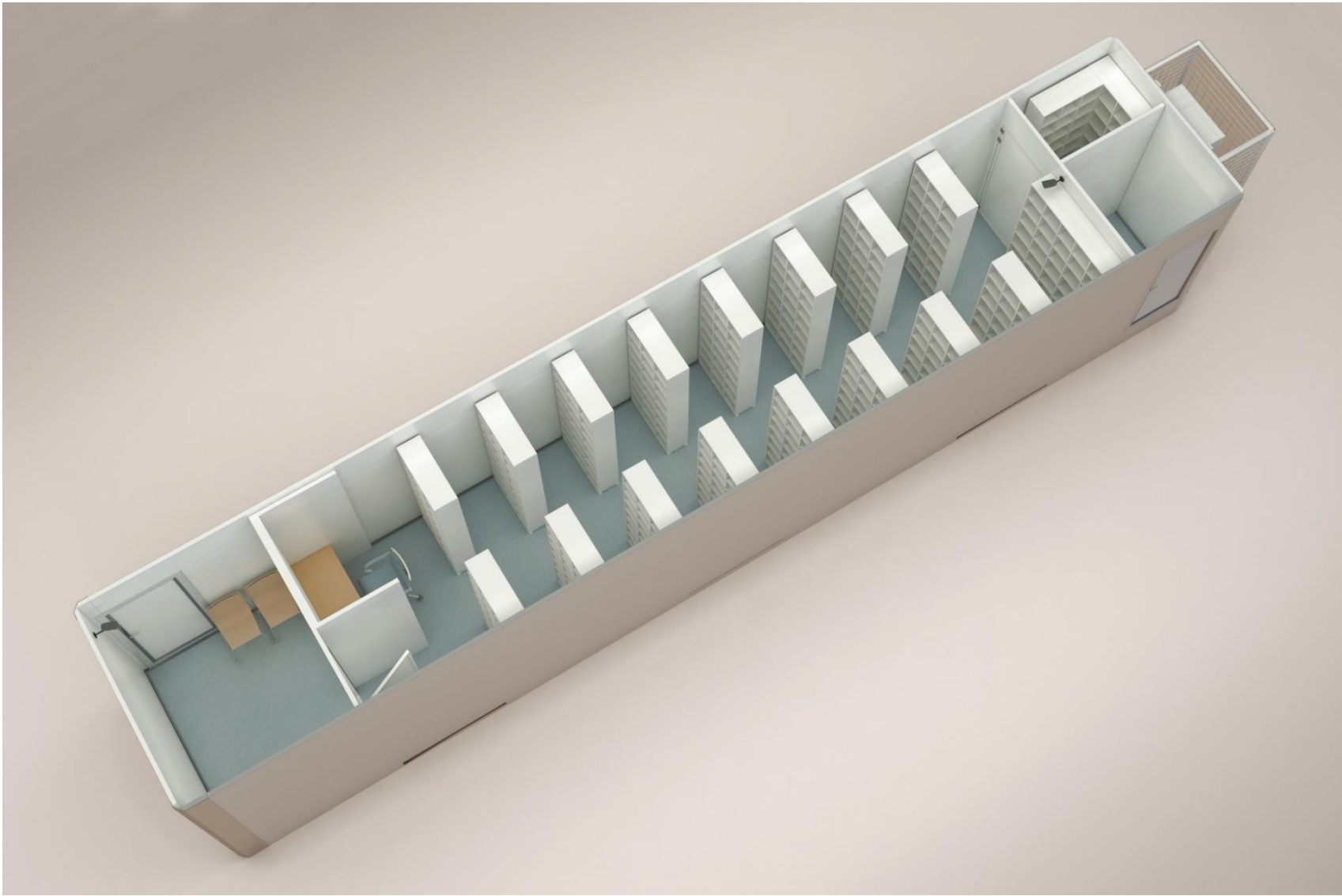

11-U4: Generator

U4

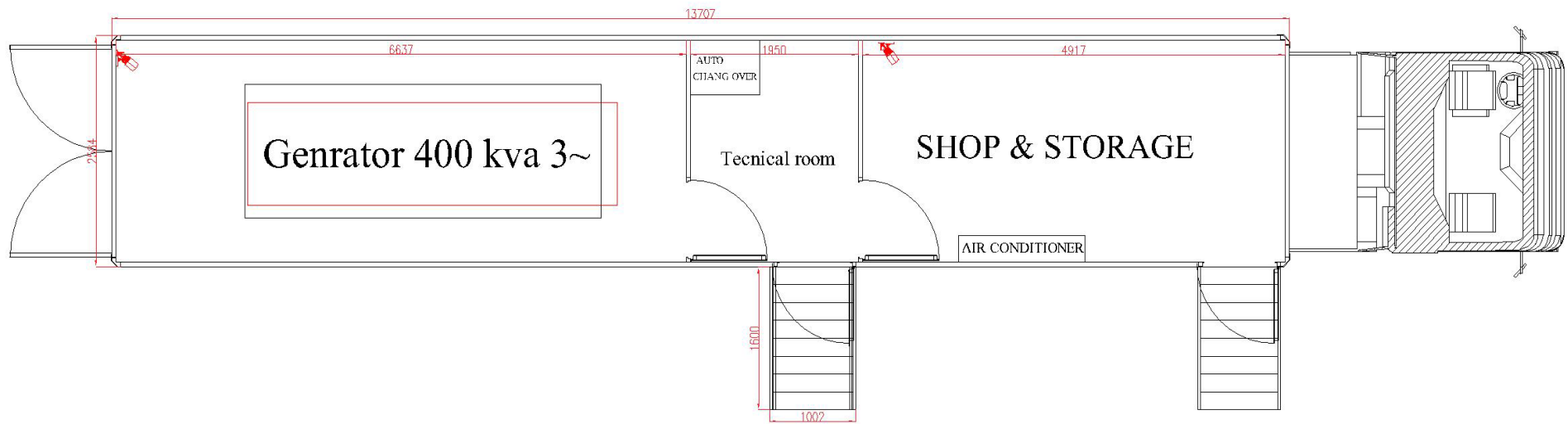

**U4: Generator -Entrance**



**U4: Generator**



**U4: Generator –Shop and storage**



**U4: Generator**

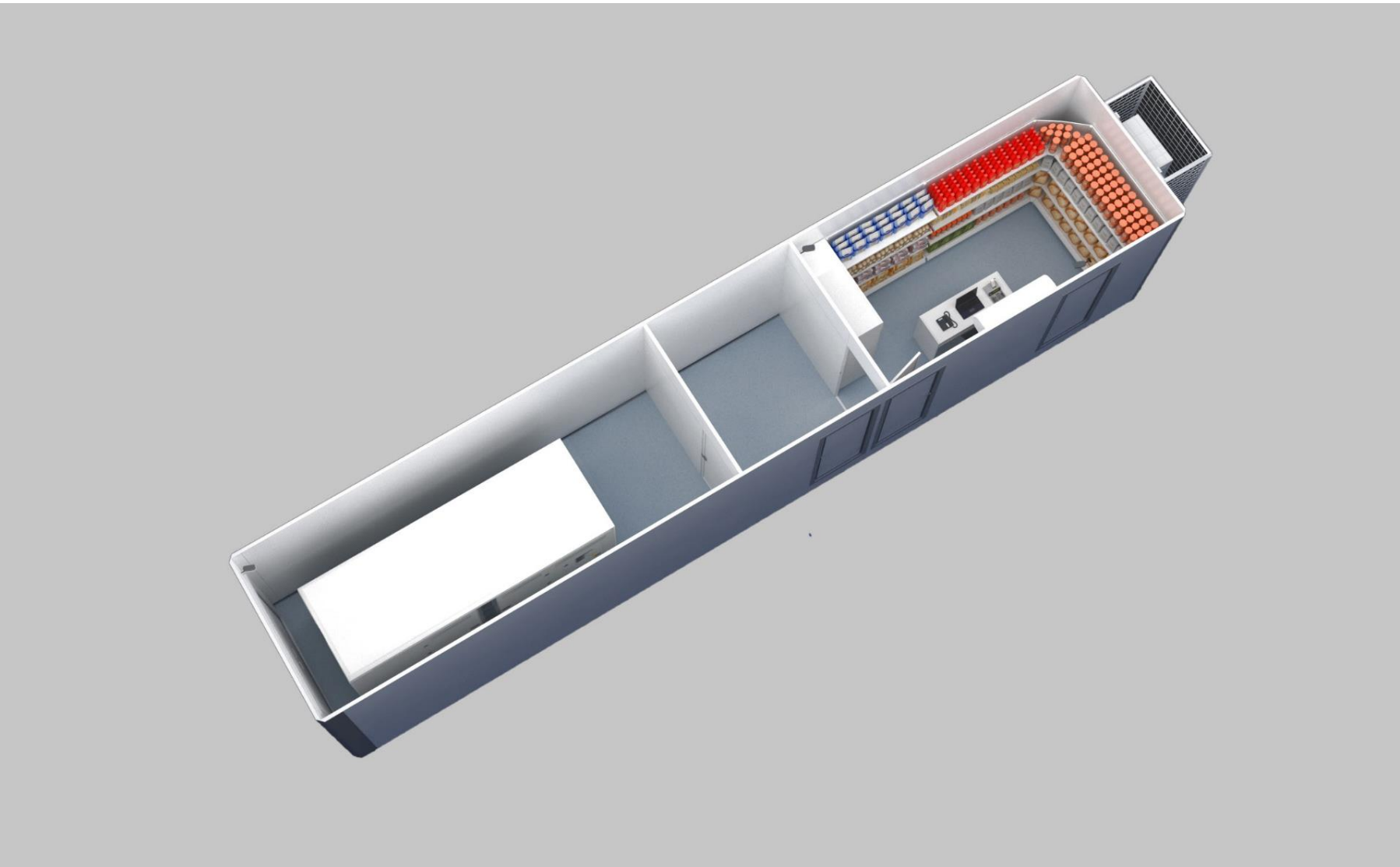

# 12-U5, U6: Rest unit for employees

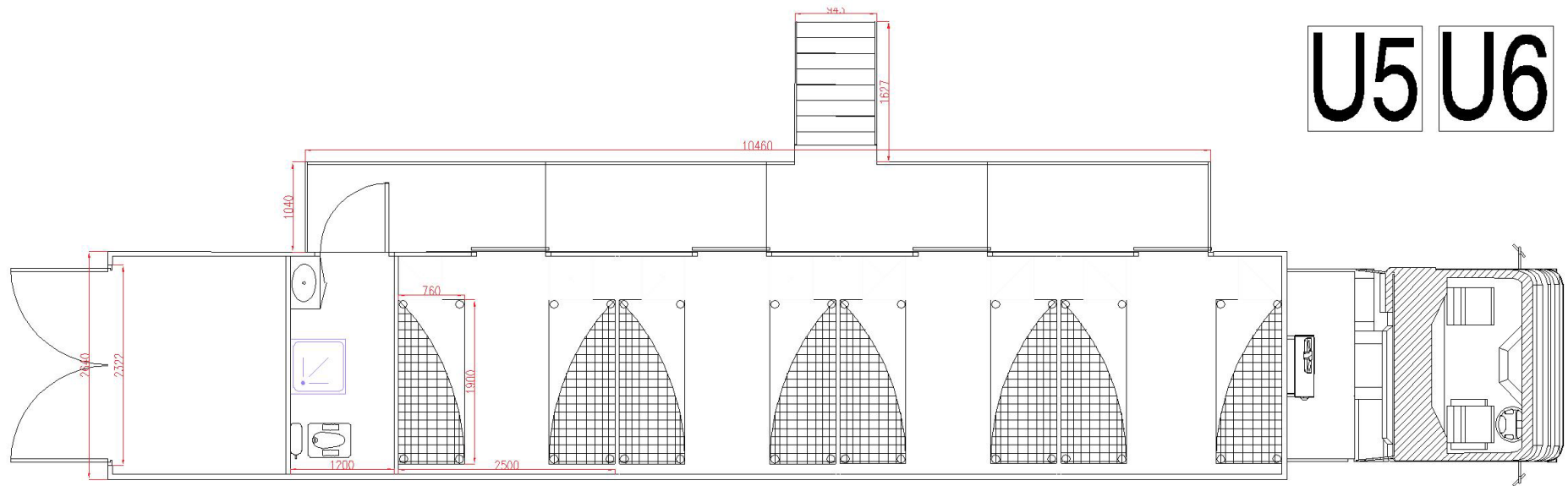

**U5, U6: Rest unit for employees**



**U5, U6: Rest unit for employees**

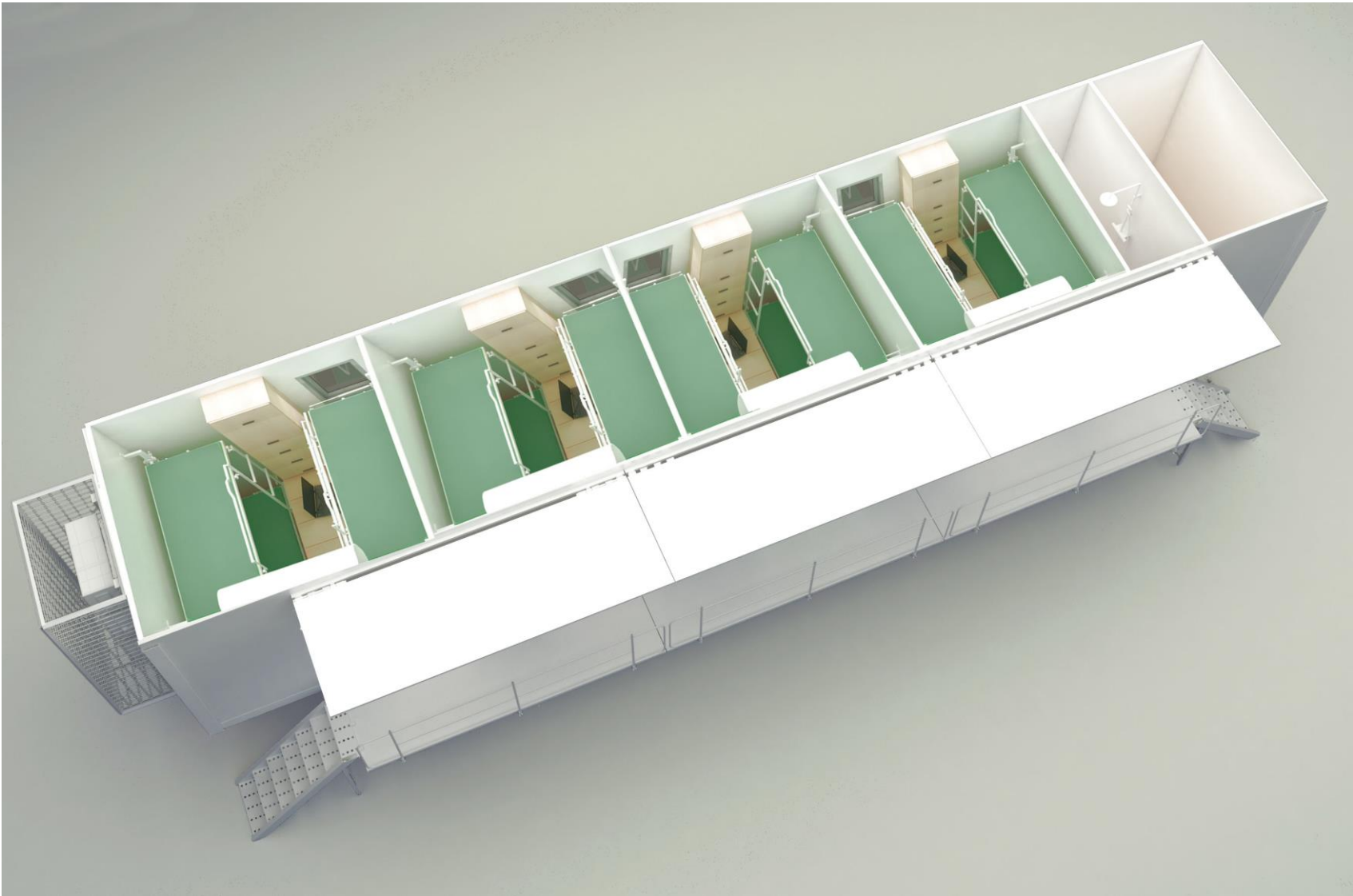

13-U7: Laboratory

U7

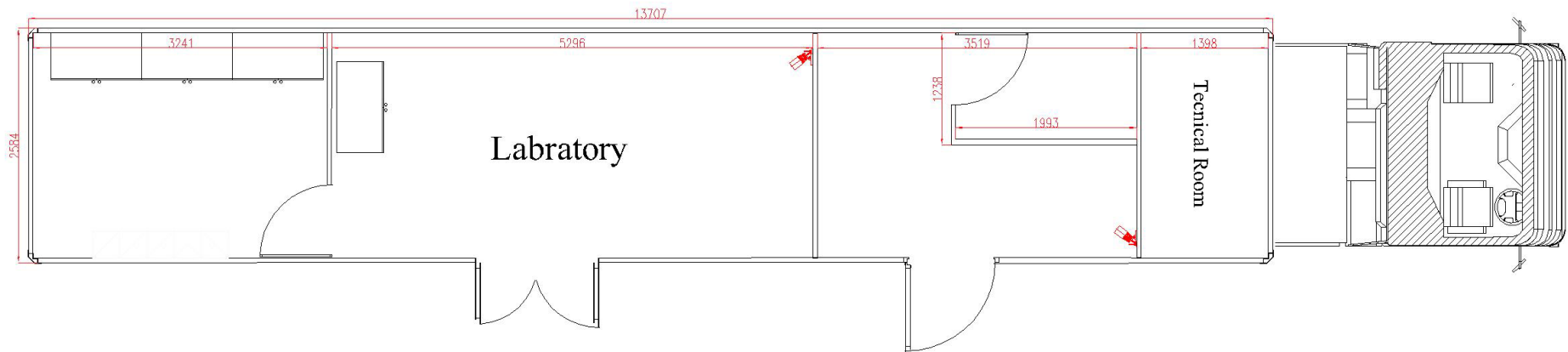

**U7: Laboratory**



**U7: Laboratory**



**U7: Laboratory -Hearing assessment**



**U7: Laboratory -Hearing assessment**



**U7: Laboratory**

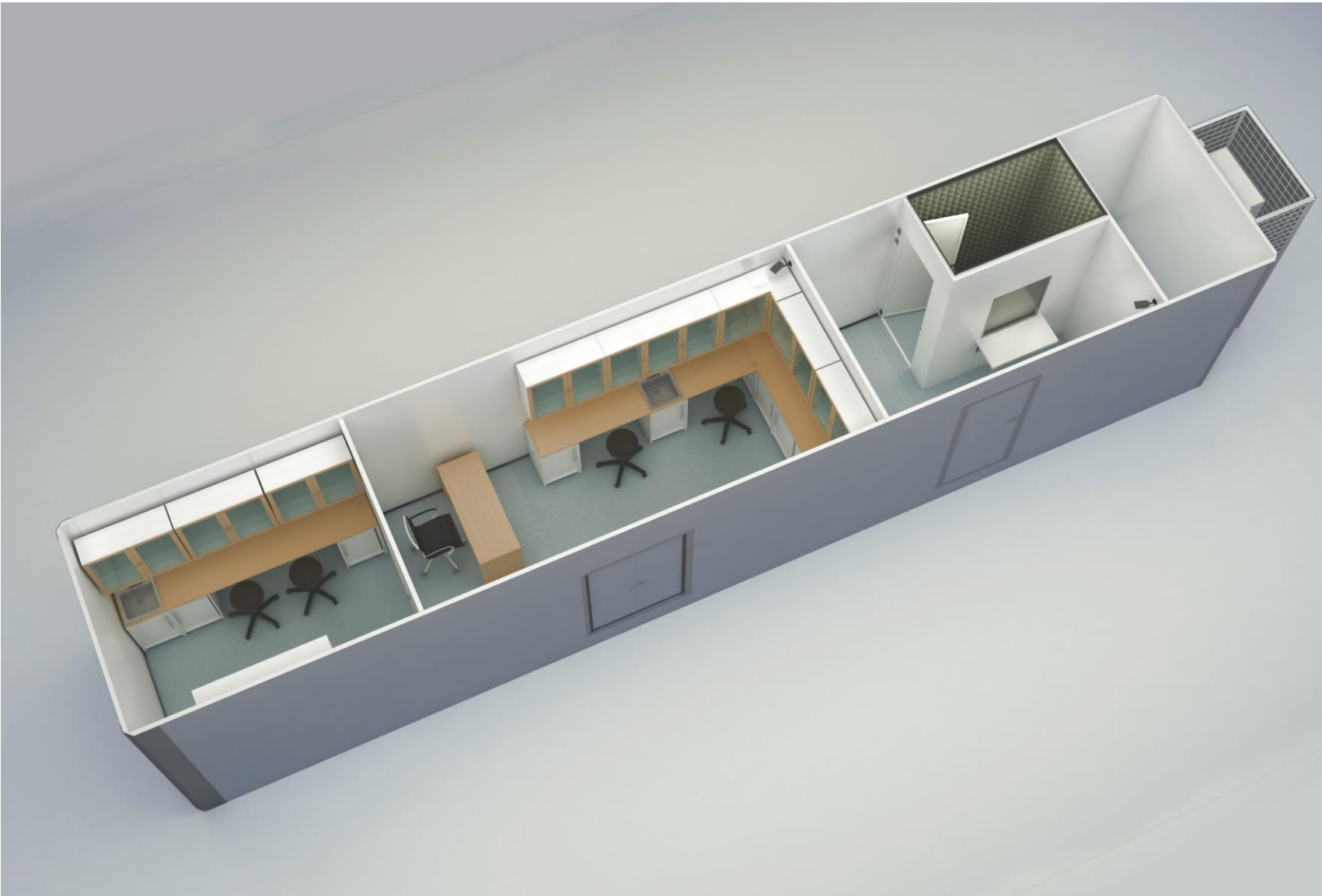

# 14-C1, C2, C3: Corridor

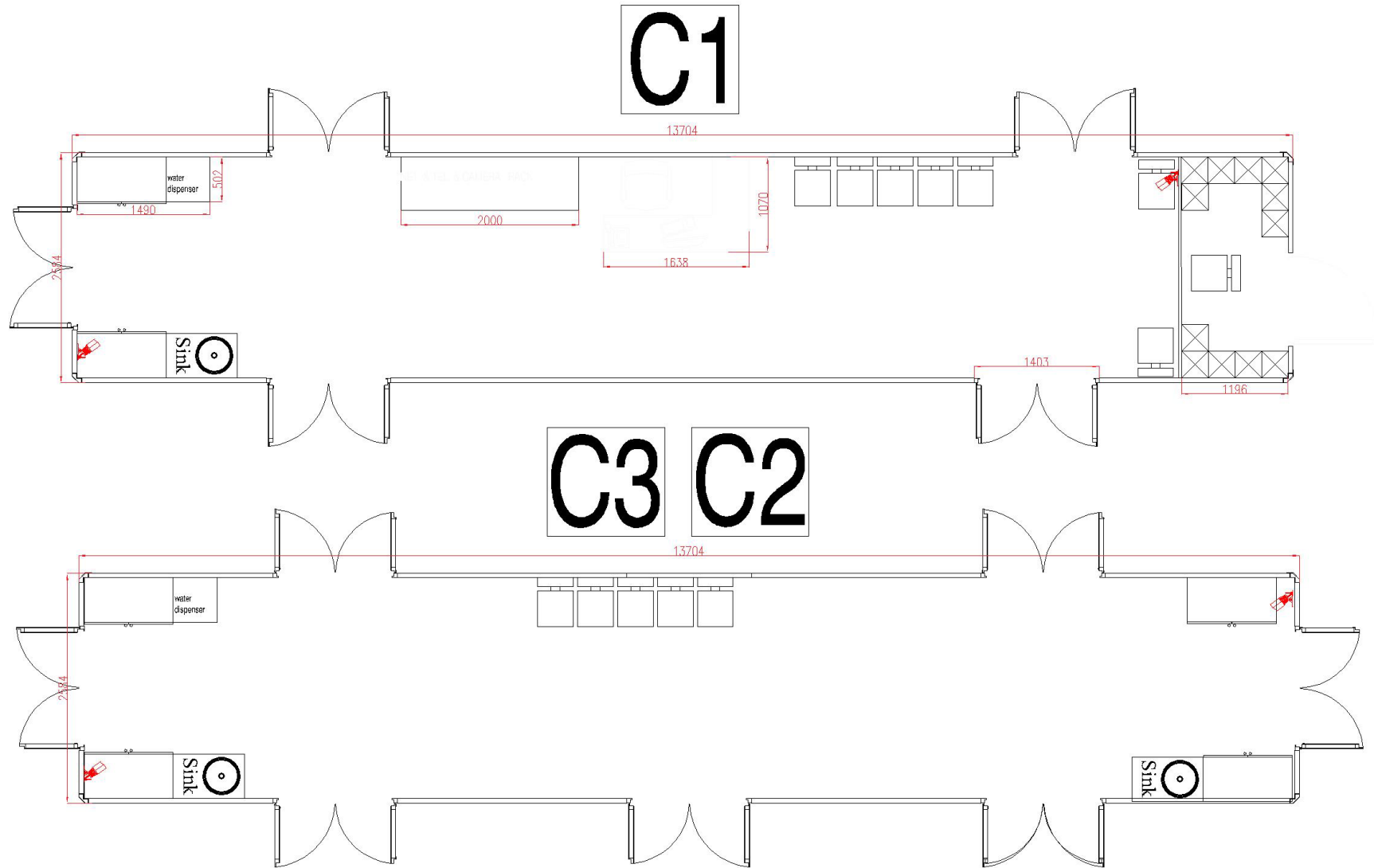

C1, C2, C3: Corridor



C1, C2, C3: Corridor



C1, C2, C3: Corridor



**14-C1, C2, C3: Corridor -pharmacy**



C1, C2, C3: Corridor

